

VALVES SERIES 70, PNEUMATIC

TECHNICAL DATA	1/8"	1/4"	1/2"
Operating pressure	Vacuum to 10 bar		
Minimum operating pressure			
• monostable	2.5 bar		
• bistable	1 bar		
Operating temperature range	-10° to 60°C		
Nominal diameter	5 mm	7.5 mm	15 mm
Conductance C [NI/min · bar]	121.43	264.26	971.43
Critical ratio b	0.32 bar/bar	0.27 bar/bar	0.43 bar/bar
Flow rate at 6 bar ΔP 0.5 bar	400 NI/min	750 NI/min	3200 NI/min
Flow rate at 6 bar ΔP 1 bar	550 NI/min	1100 NI/min	4600 NI/min
TRA/TRR monostable at 6 bar	6ms/15ms	7ms/15ms	16ms/46ms
TRA /TRR bistable at 6 bar	7ms/7ms	7ms/7ms	16ms/16ms





KEY TO CODES

P	N	V	2	3	P	N	S	N	C
FAMILY		PORT	FUNCTION		OPERATORS 14		RESETTING 12	FURTHER DETAILS	
PNV	pneumatic valves	2 1/8" 3 1/4" 4 1/2"	3 3/2 5 5/2 6 5/3		PN	pneumatic	S mechanical spring B bistable D differential O stable for 5/3 A pneumatic/mechanical spring*	OO 5/2 NC normally closed NO normally open CC closed centres OC open centres PC pressure centres	
							*on demand		

VALVES SERIES 70, PNEUMATIC, 1/8"

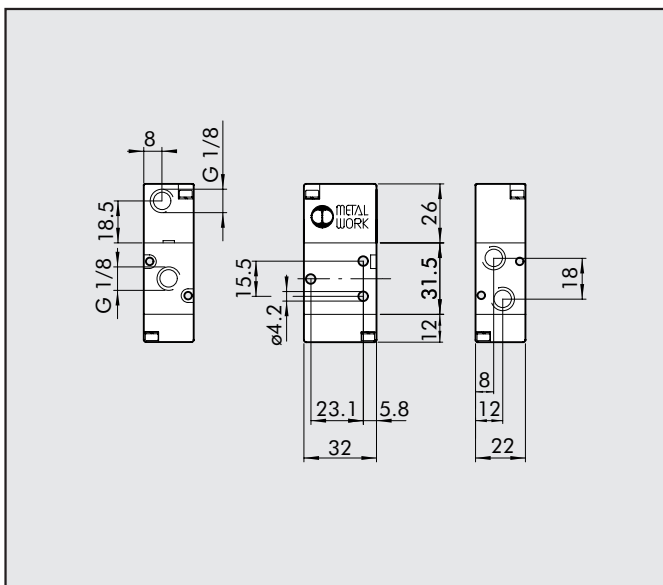
MONOSTABLE 3/2 NO, 1/8"



Symbol	Abbrev.	Code	Weight [g]
	PNV 23 PNS NO	7010010400	82

MONOSTABLE 3/2 NC, 1/8"

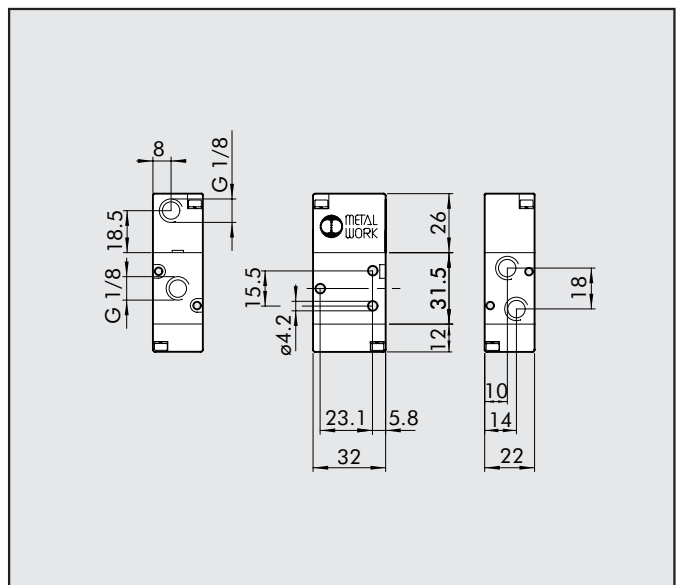

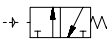
Symbol	Abbrev.	Code	Weight [g]
	PNV 23 PNS NC	7010010200	82

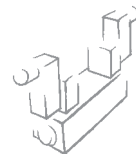

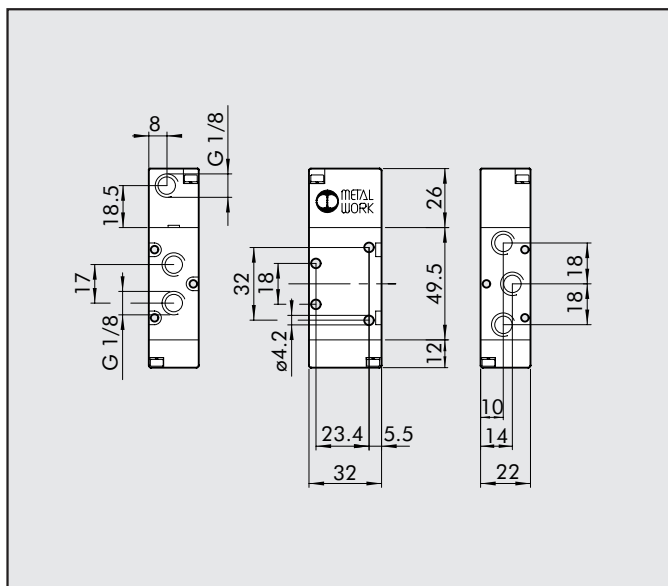

MONOSTABLE 5/2, 1/8"

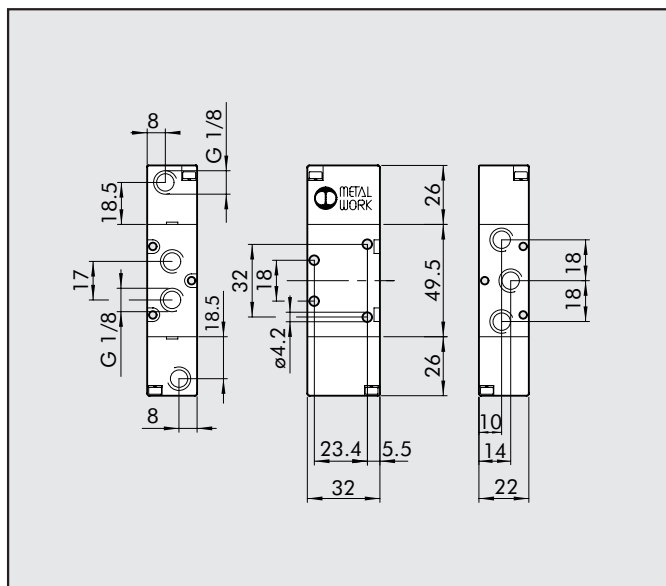

Symbol	Abbrev.	Code	Weight [g]
→  W	PNV 25 PNS OO	7010011100	108

BISTABLE 5/2, 1/8"



Symbol	Abbrev.	Code	Weight [g]
→  ←	PNV 25 PNB OO	7010011200	122
→  ←	PNV 25 PND OO	7010011300	128

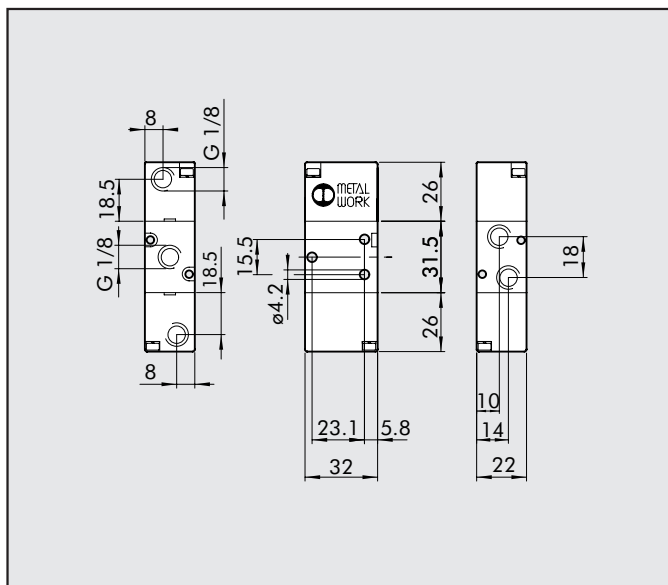

BISTABLE 3/2, 1/8"

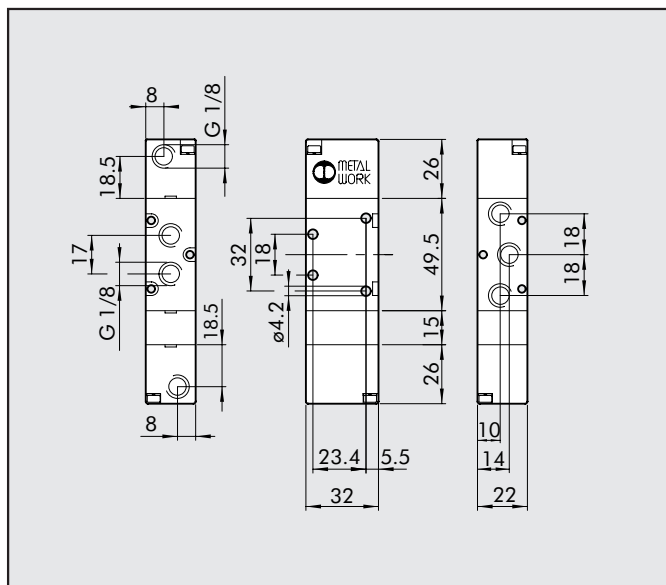

Symbol	Abbrev.	Code	Weight [g]
→  ←	PNV 23 PNB OO	7010010100	96

MONOSTABLE 5/3, 1/8"



Symbol	Abbrev.	Code	Weight [g]
→  ←	PNV 26 PNS CC	7010012100	150
→  ←	PNV 26 PNS OC	7010012200	150
→  ←	PNV 26 PNS PC	7010012300	150

VALVES SERIES 70, PNEUMATIC, 1/4"

MONOSTABLE 3/2 NO, 1/4"

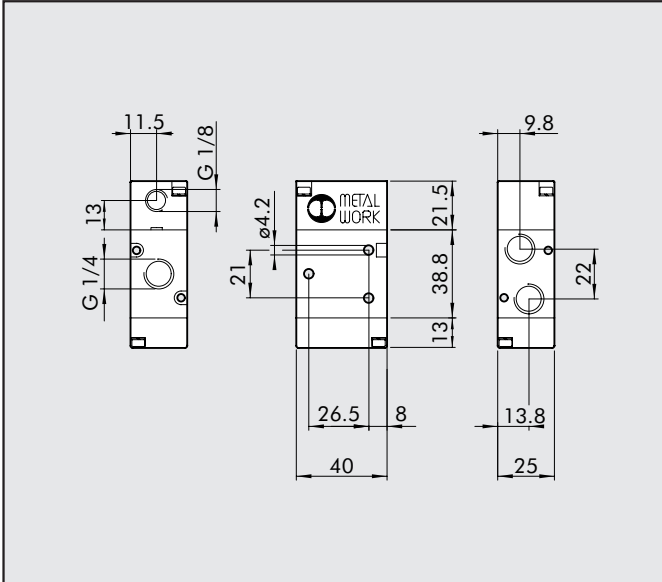

Symbol	Abbrev.	Code	Weight [g]
→ 	PNV 33 PNS NO	7020010400	124

MONOSTABLE 3/2 NC, 1/4"

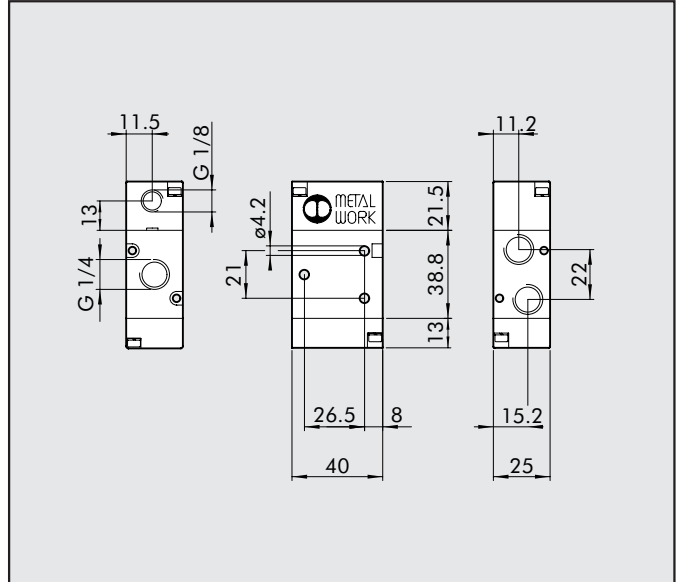

Symbol	Abbrev.	Code	Weight [g]
→ 	PNV 33 PNS NC	7020010200	122

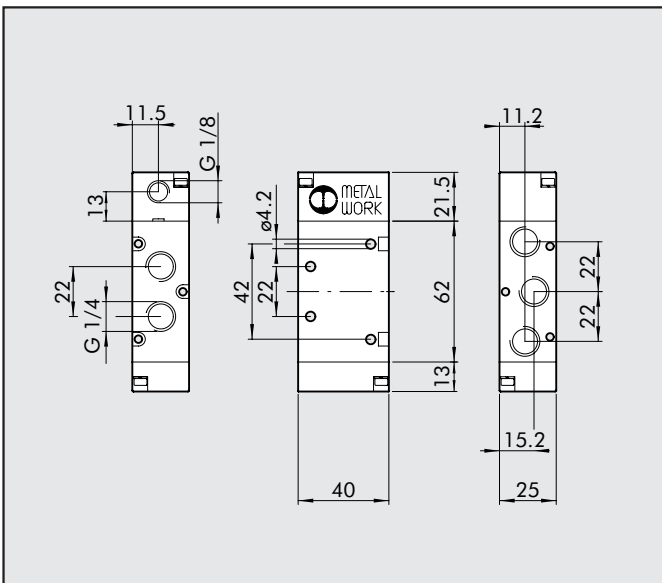

MONOSTABLE 5/2, 1/4"

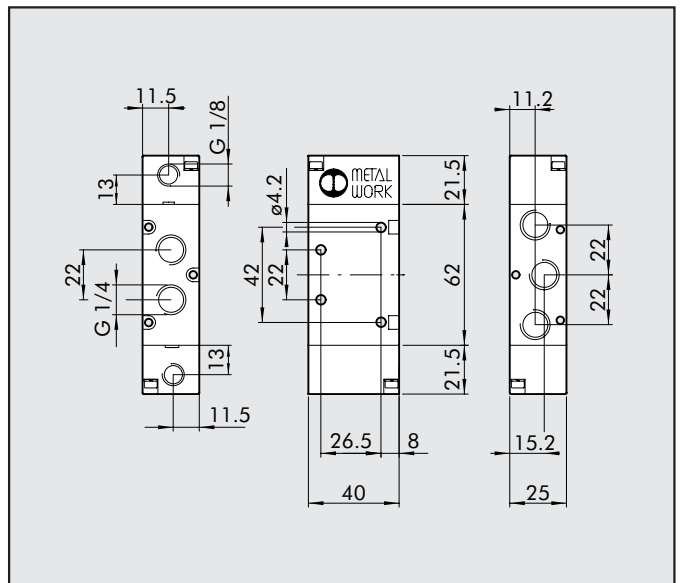

Symbol	Abbrev.	Code	Weight [g]
→ 	PNV 35 PNS OO	7020011100	174

BISTABLE 5/2, 1/4"



Symbol	Abbrev.	Code	Weight [g]
→ 	PNV 35 PNB OO	7020011200	174
↔ 	PNV 35 PND OO	7020011300	198

VALVES SERIES 70, PNEUMATIC, 1/2"

MONOSTABLE 3/2 NO, 1/2"

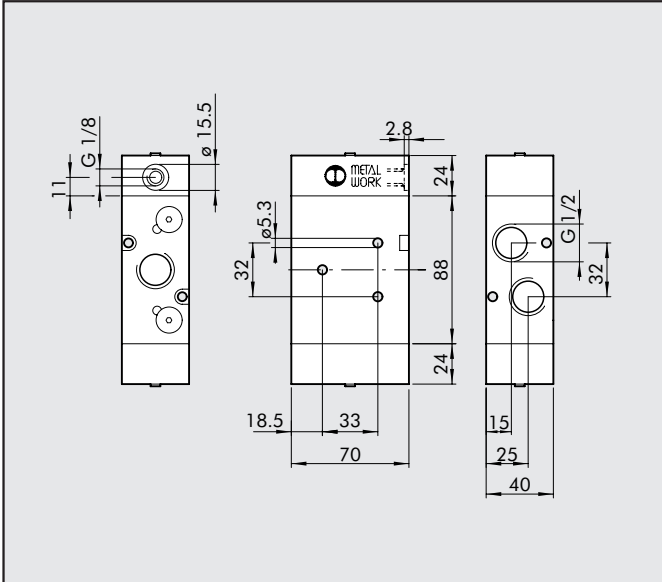

Symbol	Abbrev.	Code	Weight [g]
	PNV 43 PNS NO	7030010400	905

MONOSTABLE 3/2 NC, 1/2"

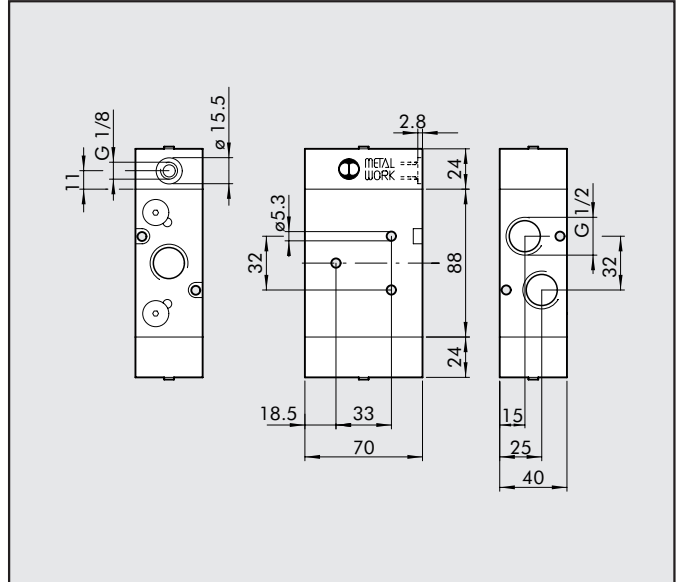

Symbol	Abbrev.	Code	Weight [g]
	PNV 43 PNS NC	7030010200	905

MONOSTABLE 5/2, 1/2"

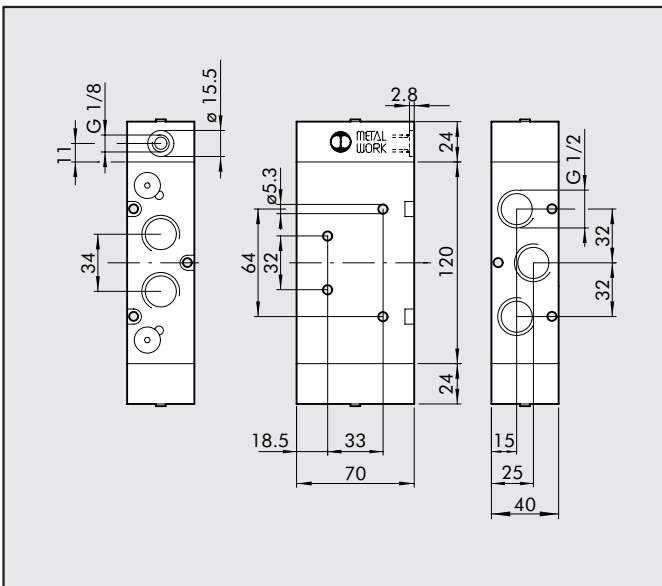

Symbol	Abbrev.	Code	Weight [g]
	PNV 45 PNS OO	7030011100	1090

BISTABLE 5/2, 1/2"

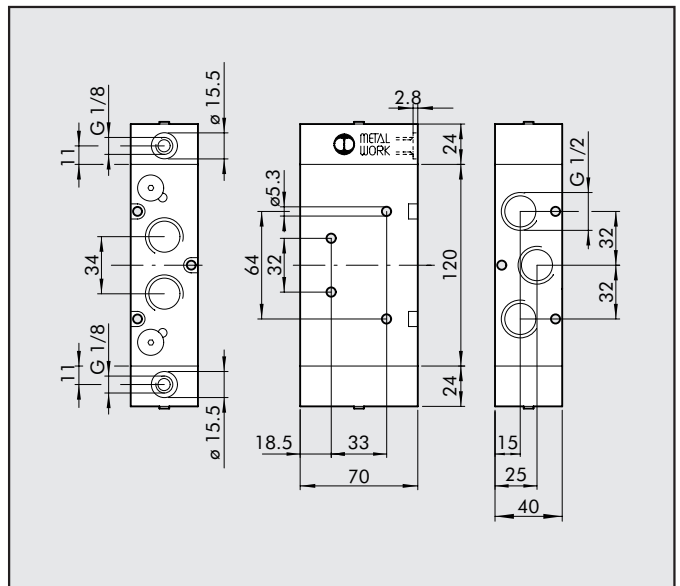

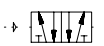
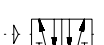
Symbol	Abbrev.	Code	Weight [g]
	PNV 45 PNB OO	7030011200	1077
	PNV 45 PND OO	7030011300	1090

