

Skillair® LUBRICATOR

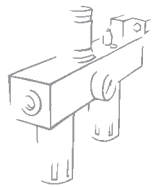

The pneumatic lubricator is the simplest way of properly lubricating actuators connected to a circuit. As air flows from the mains through the lubricator, it encounters the diaphragm which obstructs the flow and the air is forced through the Venturi tube. The inside of the Venturi tube is connected to the inspection dome, which connects with the bowl via a tube with a regulating needle in between. The drop in pressure caused by the Venturi tube sucks up air through the dome, the tube and lastly into the bowl containing oil. The quantity of oil controlled by the regulating needle then flows back from the bowl to the circuit.



TECHNICAL DATA	LUB 100	LUB 100	LUB 200	LUB 200	LUB 200	LUB 300	LUB 300	LUB 300
Threaded port	1/4"	3/8"	1/4"	3/8"	1/2"	1/2"	3/4"	1"
Type of lubrication	Mist		Mist			Mist		
Bowl capacity	50 cm ³		95			160		
Versions	Standard - CA - CD		Standard - CA - CD			Standard - CA - CD - ML CA ML - CDV - CDML		
Max. input pressure	1.5MPa - 15bar - 217psi		1.3MPa - 13bar - 188psi			1.3MPa - 13bar - 188psi		
Flow rate at 6.3 bar (0.63 MPa-91 psi)	NI/min		2200			3500		
ΔP 0.5 bar (0.05 MPa - 7 psi)	scfm		71			125		
Flow rate at 6.3 bar (0.63 MPa-91 psi)	NI/min		3700			5500		
ΔP 1 bar (0.1 MPa - 14 psi)	scfm		131			196		
Fluid	Filtered compressed air							
Max temperature	°C		50			50		
at 1 MPa; 10 bar; 145 psi	°F		122			122		
Weight	Kg		0.4			0.7		
Wall fixing screws	M4x50		M5x60			M5x70		
Mounting position	Vertical							
Recommended oils	ISO and UNI FD22 (Energol HPL ÷ Spinesso ÷ Mobil DTE ÷ Tellus Oil)							
Notes on use	Install the lubricator as close as possible to the point of use. Fill the lubricator bowl with oil before pressurizing the system. Do not use cleaning oils, brake fluid oils or solvents in general. For the best lubrication results, set the drip rate to one drop per 300-600 NI							

COMPONENTS

- ① Technopolymer body
- ② Bowl: technopolymer for LUB 100 and 200, metal for LUB 300
- ③ Technopolymer plug
- ④ Clear technopolymer glass
- ⑤ NBR Venturi tube diaphragm
- ⑥ Rilsan oil suction tube
- ⑦ Filter
- ⑧ Clear technopolymer inspection dome
- ⑨ OT58 brass oil flow regulating needle
- ⑩ OT58 brass oil filling plug
- ⑪ Zamak end plate
- ⑫ NBR gaskets

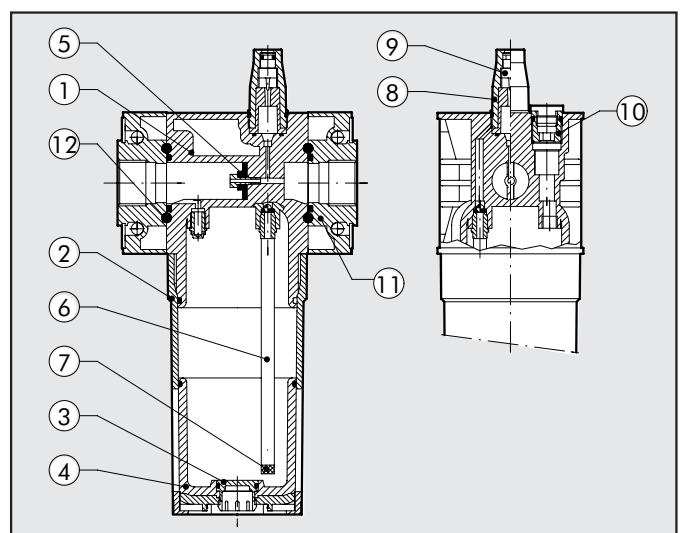

FLOW CHARTS

LUB 100 1/4 - 3/8

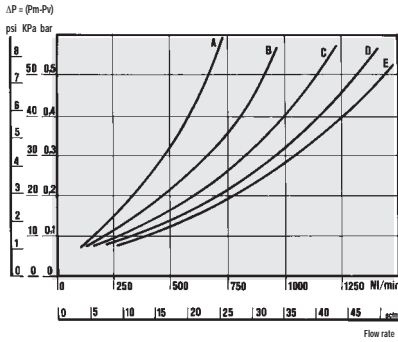

MINIMUM OPERATING FLOW CHART

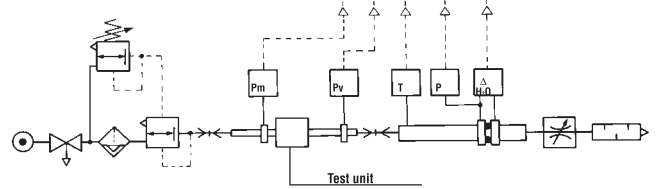
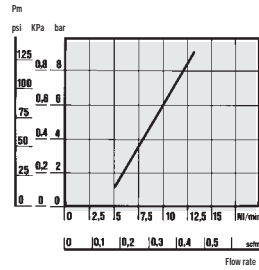

• Flow tests carried out at the Department of Mechanics, Turin Polytechnic, using the computerized test bench following CETOP RP50R recommendations (ISO DIS 6358-2-approved) with ISO 5167 diaphragm gauge.

- (A) = 2 bar - 0,2 MPa - 29 psi
- (B) = 4 bar - 0,4 MPa - 58 psi
- (C) = 6 bar - 0,6 MPa - 87 psi
- (D) = 8 bar - 0,8 MPa - 116 psi
- (E) = 10 bar - 1 MPa - 145 psi

LUB 200 1/4 - 3/8 - 1/2

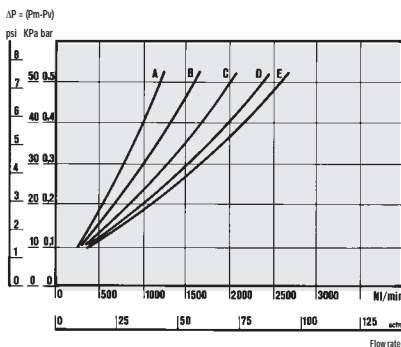

MINIMUM OPERATING FLOW CHART

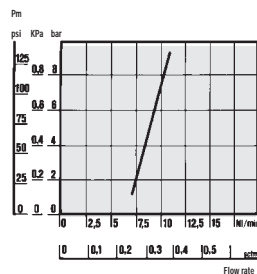

LUB 300 1/2 - 3/4 - 1

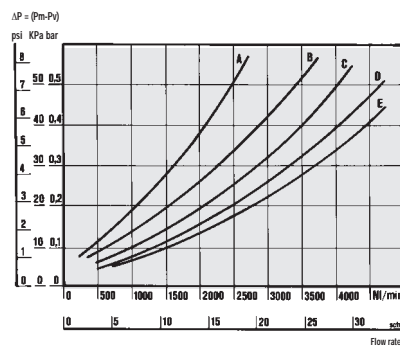

MINIMUM OPERATING FLOW CHART

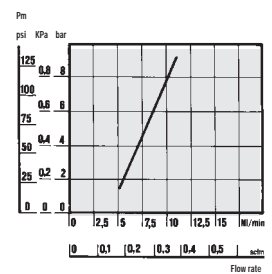

DIMENSIONS

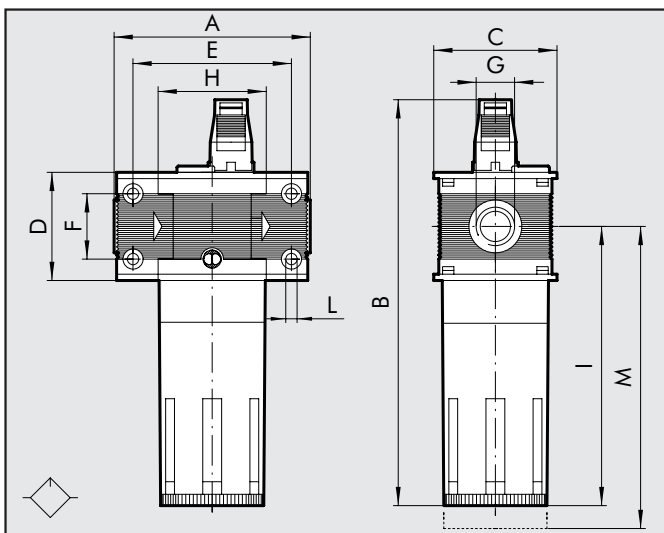

	LUB 100	LUB 100	LUB 200	LUB 200	LUB 200	LUB 300	LUB 300	LUB 300
T. Port	G 1/4	G 3/8	G 1/4	G 3/8	G 1/2	G 1/2	G 3/4	G 1"
A	78			93.5		110		112
B	162			193			214	
C	50			63			72	
D	43			55			65	
E	63			78.5			92	
F	26			36			42	
G	G 1/4	G 3/8	G 1/4	G 3/8	G 1/2	G 1/2	G 3/4	G 1"
H	43			55.5			65	
I	112			137.5			153	
L	M4 hole			M5 hole			M5 hole	
M	130			150			160	

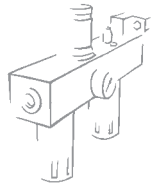

Skillair® 400 LUBRICATOR

High-performance mist lubricator in various versions.

- Activation guaranteed at low flows
- High ratio of quantity of lubricant to air flow.
- Various oil filling configurations.



TECHNICAL DATA	LUB 400			
	G 1"	G 1"1/4	G 1"1/2	G 2"
Threaded port	G 1"	G 1"1/4	G 1"1/2	G 2"
Type of lubrication	Mist			
Bowl capacity	800 cm ³			
Versions	Standard - CA - CD - ML - CA ML - CDV - CDML			
Max. input pressure	1.3 MPa			
	13 Bar			
	188 psi			
Flow rate at 6.3 bar (0.63 MPa-91 psi)	18.000 NI/min			21.000
ΔP 0.5 bar (0.05 MPa – 7 psi)	640 scfm			750
Fluid	Filtered compressed air			
Max temperature	50 °C			
at 1 MPa; 10 bar; 145 psi	122 °F			
Weight	4.9 Kg		5.7	
Wall fixing screws	M6 x 110			
Mounting position	Vertical			
Recommended oils	ISO and UNI FD22 (Energol HPL ÷ Spinesso ÷ Mobil DTE ÷ Tellus Oil)			
Notes on use	Install the lubricator as close as possible to the point of use. Fill the lubricator bowl with oil before pressurizing the system. Do not use cleaning oils, brake fluid oils or solvents in general. For the best lubrication results, set the drip rate to one drop per 300-600 NI			

3

COMPONENTS

- ① Aluminium body
- ② Aluminium bowl
- ③ Clear technopolymer glass
- ④ NBR Venturi tube diaphragm
- ⑤ Aluminium end plate
- ⑥ OT58 brass retaining ring
- ⑦ OT48 brass threaded bush with axial adjustment
- ⑧ Rilsan oil suction pipe
- ⑨ Filter
- ⑩ Technopolymer plug
- ⑪ Clear technopolymer inspection dome
- ⑫ OT58 brass oil flow regulating needle
- ⑬ OT58 brass oil filling plug
- ⑭ NBR gaskets

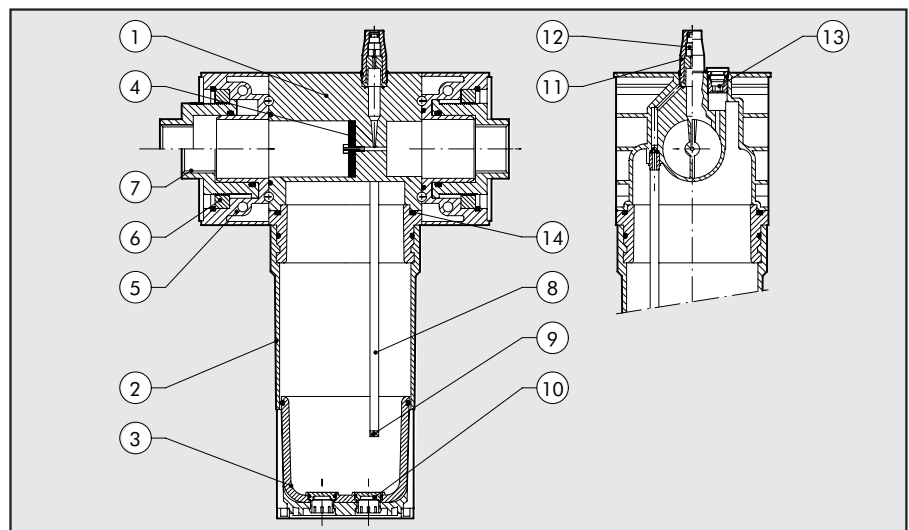

FLOW CHARTS

LUB 400 1''

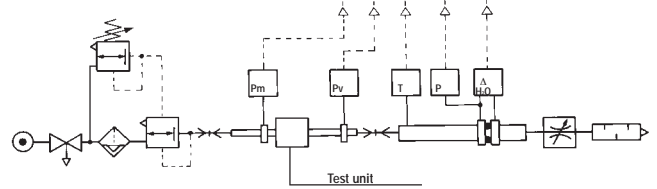
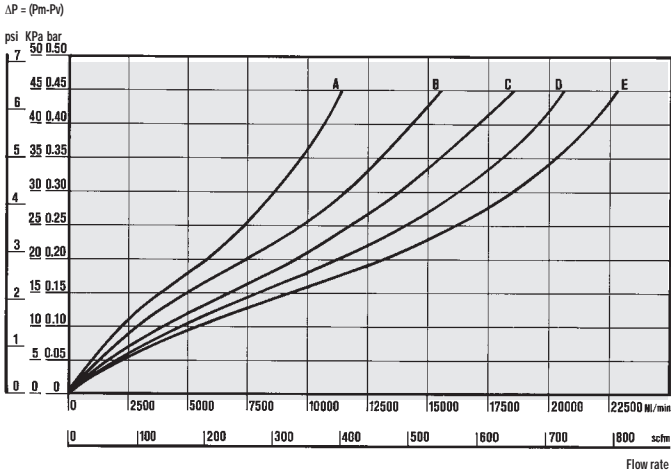

• Flow tests carried out at the Department of Mechanics, Turin Polytechnic, using the computerized test bench following CETOP RP50R recommendations (ISO DIS 6358-2-approved) with ISO 5167 diaphragm gauge.

- (A) = 2 bar - 0,2 MPa - 29 psi
- (B) = 4 bar - 0,4 MPa - 58 psi
- (C) = 6 bar - 0,6 MPa - 87 psi
- (D) = 8 bar - 0,8 MPa - 116 psi
- (E) = 10 bar - 1 MPa - 145 psi

LUB 400 2''

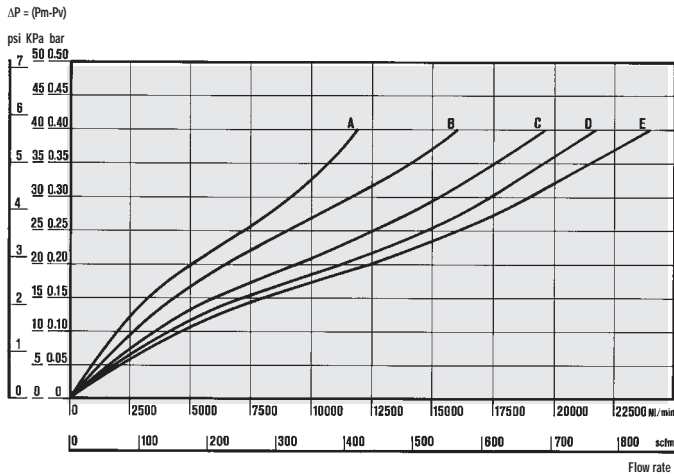

MINIMUM OPERATING FLOW CHART

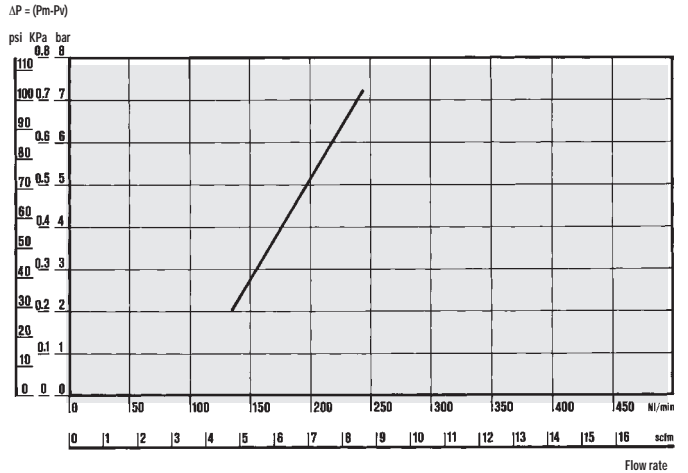

DIMENSIONS

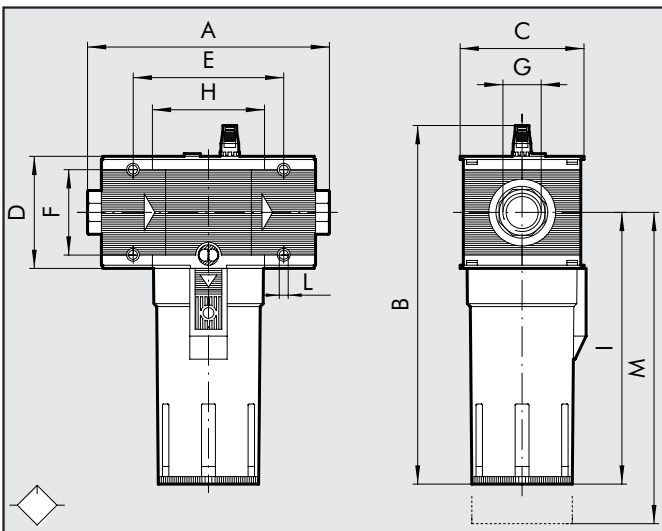

	LUB 400	LUB 400	LUB 400	LUB 400
Threaded port	G 1''	G 1''/4	G 1''/2	G 2''
A		225÷255		283÷313
B			338	
C			116	
D			105	
E			141.4	
F			80	
G	G 1''	G 1''/4	G 1''/2	G 2''
H			105.4	
I			256	
L			M6 hole	
M			285	

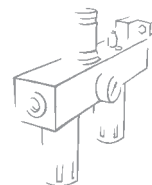

LUBRICATORS : MINIMUM LEVEL (ML)

Available in sizes 300 and 400.
This version gives two electric signals controlling maximum and minimum level. They can be used to control acoustic alarms, lights, etc. There is no signal between minimum and maximum level.

WIRING
Level indicator
 White = 1st signal (maximum oil level)
 Brown = 2nd signal (minimum oil level)
 Orange = Common
 Yellow/Green = Earth
 Voltage = 24V
 Contact = 0.75 A 10W

NB: The unused end plate must be suitably insulated.

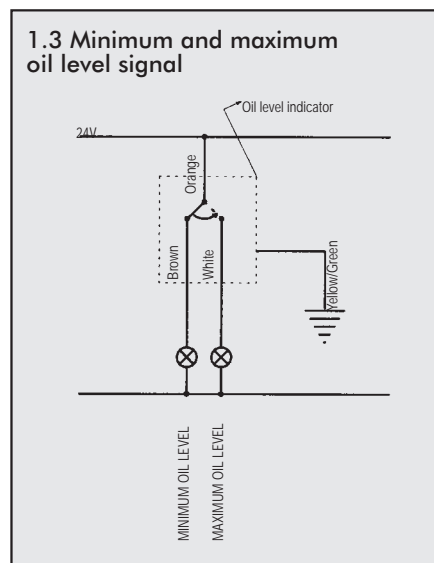
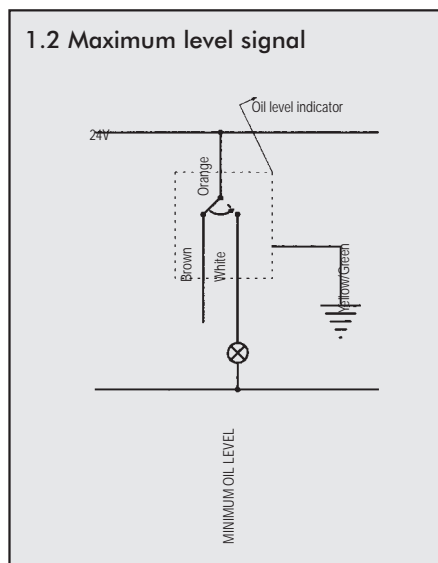
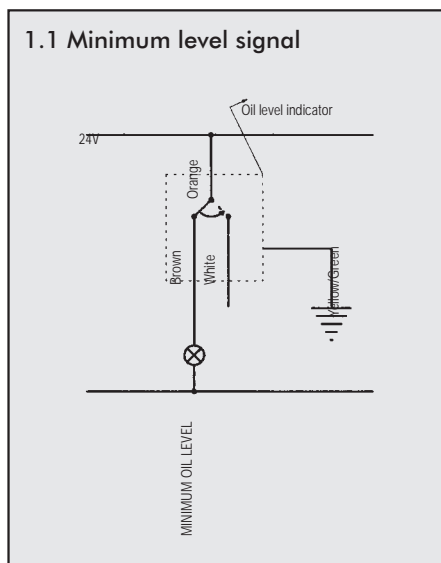

LUBRICATORS: AUTOMATIC MINIMUM LEVEL FILLING (CAML)

Available in size 300 and 400.
Used for filling the bowl with oil during operation of the system only if the oil inlet pressure is higher than the pressure inside the lubricator bowl.
The electric indicator inside the bowl sends an electric signal that is used to activate the oil unit.
When the oil reaches the maximum level, another signal deactivates the unit. In this case the lubrication system operates with

the oil level between the maximum and minimum values. If it is necessary to keep the oil level in the bowl constant, only one of the two signals can be used. Pressure range 3-10 bar. Connect the pipe from the central unit to the G1/4 fitting on the bowl. The wiring features are the same as for model ML.

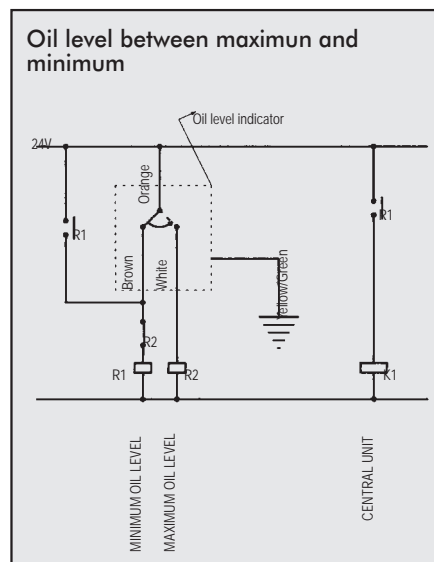
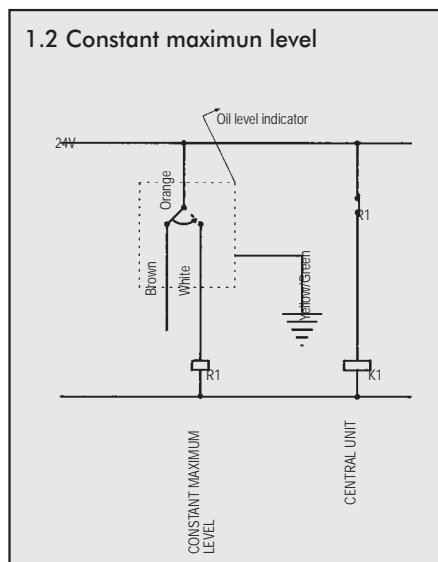
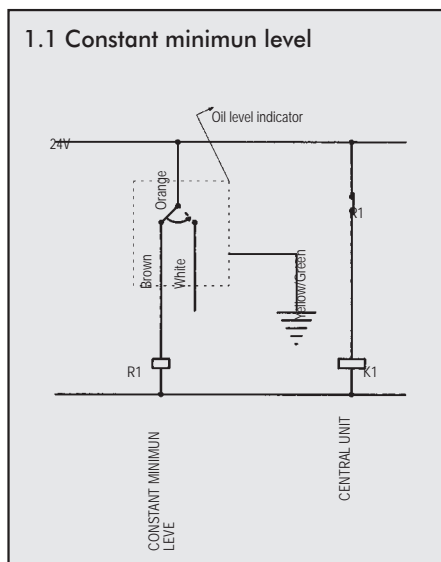

LUBRICATOR: DEPRESSION FILLING WITH MINIMUM LEVEL (CD ML)

DEPRESSION FILLING WITH MINIMUM LEVEL

Available in sizes 300 and 400, this lubricator is controlled by a solenoid valve (2/2 NC minimum bore 3) situated on the lubricator body. It reduces pressure inside the bowl allow it to be filled with oil taken from a tank at ambient pressure, which can be located in a lower position than the lubricator (max. difference in height 2 m). The electric indicator inside the bowl sends

an electric signal used to activate the valve. When the oil reaches the maximum level, another signal disactivates the valve. In this case, the lubricator system operates with the oil level between minimum and maximum. If it is necessary to keep the oil level in the bowl constant, only one of the two signals can be used. Pressure range 3-10 bar. Connect the oil tank to the G1/4 fitting on the bowl.

1.1 Constant minimum level

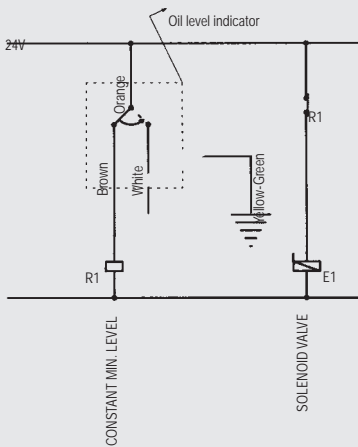

1.2 Constant maximum level

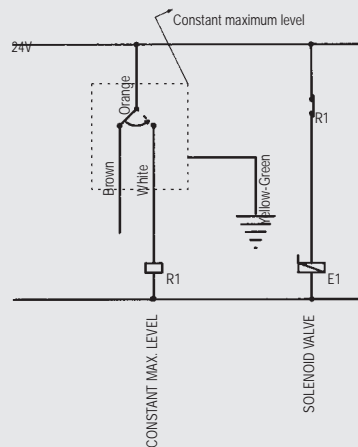

1.3 Oil level between maximum and minimum

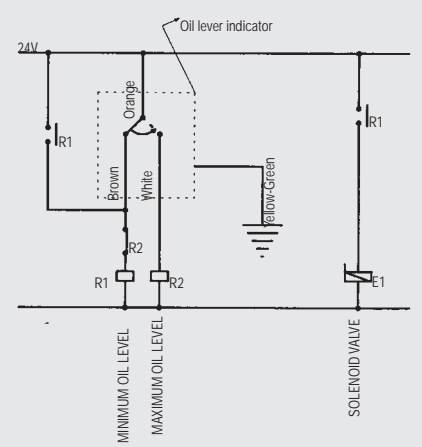

OTHER VERSIONS SHOWN IN THE CATALOGUE

AUTOMATIC FILLING (CA)

Available in all sizes. The bowl is only filled with oil during operation of the system if the oil inlet pressure is about 3 bar higher than the pressure inside the bowl. In any case, it must not exceed 15 bar.

The float opens and closes the oil intake valve. Lubrication continues during oil filling. The timer can be used to control the central unit so that cycles are performed between zero and the filling pressure. These timed cycles allow the oil level in the lubricator to be topped up.

Connect the tube from the central unit to the G1/8 fitting below the bowl.

FILLING BY DEPRESSION (CD)

Available in all sizes. It is operated by means of a button on the lubricator body. The pressure inside the bowl drops to allow it to be filled with oil taken from a tank at ambient pressure, which can be located in a lower position than the lubricator (max. difference in height 2 m). Oil filling stops when the level of oil raises the float and shuts off a specific valve.

Important – The SK4 lubricator is filled with oil by hand. Filling must stop when the oil level is visible through the spy-hole in the bowl release lever. Pressure range 3-10 bar. Lubrication is discontinued during filling. Connect the oil tank to the G1/4 fitting below the bowl.

FILLING BY DEPRESSION (CVD) WITH VALVE

Available in sizes 300 and 400. It is operated by means of a solenoid valve (2/2 NC minimum bore 3) situated on the lubricator body. The pressure inside the bowl drops to allow it to be filled with oil taken from a tank at ambient pressure, which can be located in a lower position than the lubricator (max. difference in height 2 m). Oil filling stops when the level of oil raises the float and shuts off a specific valve.

Important – The SK4 lubricator is filled with oil by hand. Filling must stop when the oil level is visible through the spy-hole in the bowl release lever. Pressure range 3-10 bar. Lubrication is discontinued during filling. Connect the oil tank to the G1/4 fitting below the bowl.

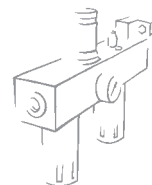

KEY TO CODES

LUB	100	1/4	STD
ELEMENT	SIZE	THREADED PORT	TYPE OF OIL FILLING
LUB	100	1/4	STD
		3/8	CA
	200	1/4	CD
		3/8	STD
		1/2	CA
	300	1/2	CD
		3/4	ML
		1	CA ML
		1	CDV
	400	1	CD ML
		1 1/4	
		1 1/2	
		2	

STD: Standard version filled with oil by removing the bowl or through the top cap. Requires circuit relieving.

ORDERING CODES

Code	Description	Code	Description	Code	Description
LUBRICATOR 100		LUBRICATOR 300		LUBRICATOR 400	
3281001A	LUB 100 WITHOUT END PLATES	4481001A	LUB 300 WITHOUT END PLATES	6181001A	LUB 400 WITHOUT END PLATES
3281002A	LUB 100 CA WITHOUT END PLATES	4481002A	LUB 300 CA WITHOUT END PLATES	6181002A	LUB 400 CA WITHOUT END PLATES
3281005A	LUB 100 CD MANUAL W/END PLATES	4481003A	LUB 300 ML MANUAL W/END PLATES	6181003A	LUB 400 ML WITHOUT END PLATES
3281001	LUB 100 1/4	4481005A	LUB 300 CD MANUAL W/END PLATES	6181004A	LUB 400 CD MANUAL W/END PLATES
3281002	LUB 100 1/4 CA	4481006A	LUB 300 ML-CD AUTOMATIC W/END PLATES	6181006A	LUB 400 ML-CD AUTOMATIC W/END PLATES
3281005	LUB 100 1/4 CD MANUAL	4481007A	LUB 300 ML-CA WITHOUT END PLATES	6181007A	LUB 400 ML-CA WITHOUT END PLATES
3381001	LUB 100 3/8	4481008A	LUB 300 CD AUTOMATIC W/END PLATES	6181008A	LUB 400 CD AUTOMATIC W/END PLATES
3381002	LUB 100 3/8 CA	4481001	LUB 300 1/2	6181001	LUB 400 1
3381005	LUB 100 3/8 CD MANUAL	4481002	LUB 300 1/2 CA	6181002	LUB 400 1 CA
		4481003	LUB 300 1/2 ML	6181003	LUB 400 1 ML
LUBRICATOR 200		4481005	LUB 300 1/2 CD MANUAL	6181004	LUB 400 1 CD MANUAL
3481001A	LUB 200 WITHOUT END PLATES	4481006	LUB 300 1/2 ML-CD AUTOMATIC	6181006	LUB 400 1 ML-CD AUTOMATIC
3481002A	LUB 200 CA WITHOUT END PLATES	4481007	LUB 300 1/2 ML-CA	6181007	LUB 400 1 ML-CA
3481005A	LUB 200 CD MANUAL W/END PLATES	4481008	LUB 300 1/2 CD AUTOMATIC	6181008	LUB 400 1 CD AUTOMATIC
3481001	LUB 200 1/4	4581001	LUB 300 3/4	6281001	LUB 400 1 1/4
3481002	LUB 200 1/4 CA	4581002	LUB 300 3/4 CA	6281002	LUB 400 1 1/4 CA
3481005	LUB 200 1/4 CD MANUAL	4581003	LUB 300 3/4 ML	6281003	LUB 400 1 1/4 ML
3581001	LUB 200 3/8	4581005	LUB 300 3/4 CD MANUAL	6281004	LUB 400 1 1/4 CD MANUAL
3581002	LUB 200 3/8 CA	4581006	LUB 300 3/4 ML-CD AUTOMATIC	6281006	LUB 400 1 1/4 ML-CD AUTOMATIC
3581005	LUB 200 3/8 CD MANUAL	4581007	LUB 300 3/4 ML-CA	6281007	LUB 400 1 1/4 ML-CA
3681001	LUB 200 1/2	4581008	LUB 300 3/4 CD AUTOMATIC	6281008	LUB 400 1 1/4 CD AUTOMATIC
3681002	LUB 200 1/2 CA	4681001	LUB 300 1	6381001	LUB 400 1 1/2
3681005	LUB 200 1/2 CD MANUAL	4681002	LUB 300 1 CA	6381002	LUB 400 1 1/2 CA
		4681003	LUB 300 1 ML	6381003	LUB 400 1 1/2 ML
		4681005	LUB 300 1 CD MANUAL	6381004	LUB 400 1 1/2 CD MANUAL
		4681006	LUB 300 1 ML-CD AUTOMATIC	6381006	LUB 400 1 1/2 ML-CD AUTOMATIC
		4681007	LUB 300 1 ML-CA	6381007	LUB 400 1 1/2 ML-CA
		4681008	LUB 300 1 CD AUTOMATIC	6381008	LUB 400 1 1/2 CD AUTOMATIC
				6481001	LUB 400 2
				6481002	LUB 400 2 CA
				6481003	LUB 400 2 ML
				6481004	LUB 400 2 CD MANUAL
				6481006	LUB 400 2 ML-CD AUTOMATIC
				6481007	LUB 400 2 ML-CA
				6481008	LUB 400 2 CD AUTOMATIC